



# Vehicle History Report™

US \$39.99

## 2004 CHEVROLET EXPRESS G1500

VIN: 1GBFG15T341203970  
VAN  
5.3L V8 F  
GASOLINE  
REAR WHEEL DRIVE



Accident reported



42 Service history records



3 Previous owners



Personal vehicle



Last owned in California



126,193 Last reported odometer reading

This CARFAX Vehicle History Report is based only on information supplied to CARFAX and available as of 11/3/22 at 1:57:25 PM (CDT). Other information about this vehicle, including problems, may not have been reported to CARFAX. Use this report as one important tool, along with a vehicle inspection and test drive, to make a better decision about your next used car.



## Ownership History

The number of owners is estimated

	Owner 1	Owner 2	Owner 3
Year purchased	2004	2019	2022
Type of owner	Personal	Personal	Personal
Estimated length of ownership	14 yrs. 11 mo.	3 years	20 days
Owned in the following states/provinces	Texas	California	California
Estimated miles driven per year	7,940/yr	1,695/yr	---
Last reported odometer reading	118,497	126,193	---



## Title History

CARFAX guarantees the information in this section

	Owner 1	Owner 2	Owner 3
<b>Damage Brands</b> Salvage   Junk   Rebuilt   Fire   Flood   Hail   Lemon	<input checked="" type="checkbox"/> <b>Guaranteed</b> No Problem	<input checked="" type="checkbox"/> <b>Guaranteed</b> No Problem	<input checked="" type="checkbox"/> <b>Guaranteed</b> No Problem

<b>Odometer Brands</b> Not Actual Mileage   Exceeds Mechanical Limits	<input checked="" type="checkbox"/> <b>Guaranteed</b> No Problem	<input checked="" type="checkbox"/> <b>Guaranteed</b> No Problem	<input checked="" type="checkbox"/> <b>Guaranteed</b> No Problem
--	---	---	---



**GUARANTEED** - None of these major title problems were reported by a state Department of Motor Vehicles (DMV). If you find that any of these title problems were reported by a DMV

<b>CARFAX</b> <b>Additional History</b> Not all accidents / issues are reported to CARFAX	Owner 1	Owner 2	Owner 3
<b>Total Loss</b> No total loss reported to CARFAX.	<input checked="" type="checkbox"/> No Issues Reported	<input checked="" type="checkbox"/> No Issues Reported	<input checked="" type="checkbox"/> No Issues Reported
<b>Structural Damage</b> CARFAX recommends that you have this vehicle inspected by a collision repair specialist.	<input checked="" type="checkbox"/> No Issues Reported	<input checked="" type="checkbox"/> No Issues Reported	<input checked="" type="checkbox"/> No Issues Reported
<b>Airbag Deployment</b> No airbag deployment reported to CARFAX.	<input checked="" type="checkbox"/> No Issues Reported	<input checked="" type="checkbox"/> No Issues Reported	<input checked="" type="checkbox"/> No Issues Reported
<b>Odometer Check</b> No indication of an odometer rollback.	<input checked="" type="checkbox"/> No Issues Indicated	<input checked="" type="checkbox"/> No Issues Indicated	<input checked="" type="checkbox"/> No Issues Indicated
<b>Accident / Damage</b> Accident reported: 05/14/2015.	Accident Reported	No New Issues Reported	No New Issues Reported
<b>Manufacturer Recall</b> No open recalls reported to CARFAX. Check for open recalls on GM vehicles at recalls.gm.com.	<input checked="" type="checkbox"/> No Recalls Reported	<input checked="" type="checkbox"/> No Recalls Reported	<input checked="" type="checkbox"/> No Recalls Reported



## Detailed History



**Owner 1**  
Purchased:  
2004



**Low mileage!** This owner drove less than the industry average of 15,000 miles per year.

Personal Vehicle  
7,940 mi/yr

Date	Mileage	Source	Comments
------	---------	--------	----------

































07/26/2004	Randall Noe Auto Group Terrell, TX 972-524-3775 ★ 4.5 / 5.0 89 Verified Reviews		<b>Vehicle serviced</b> VIN glass etching vin etched
11/03/2004 581	Dealer Inventory Texas		<b>Vehicle sold</b>
11/03/2004	Service Facility		<b>Vehicle serviced</b> VIN glass etching vin etched Tire condition and pressure checked Spare tire lock installed Vehicle washed/detailed Emissions or safety inspection performed
11/03/2004	Van Chevrolet Carrollton, TX 972-389-6700		<b>Vehicle serviced</b>
11/03/2004	Texas Motor Vehicle Dept. Southlake, TX		<b>Titled or registered as personal vehicle</b>
01/19/2005	Texas Motor Vehicle Dept. Southlake, TX Title #05755338360151511		<b>Title issued or updated</b> Registration issued or renewed First owner reported Passed safety inspection Vehicle color noted as Black
05/02/2005	Van Chevrolet Carrollton, TX 972-389-6700		<b>Vehicle serviced</b>
01/01/2006	Texas Motor Vehicle Dept. Southlake, TX Title #05755338360151511		<b>Registration issued or renewed</b> Passed safety inspection
02/17/2006	Van Chevrolet Carrollton, TX 972-389-6700		<b>Vehicle serviced</b>

07/11/2006	10,895	Classic Chevrolet Grapevine, TX 817-421-1200 ★ 4.6 / 5.0 886 Verified Reviews 14,94 Customer 5 Favorites	<b>Vehicle serviced</b> Oil and filter changed
08/28/2006	15,388	Classic Chevrolet Grapevine, TX 817-421-1200 ★ 4.6 / 5.0 886 Verified Reviews 14,94 Customer 5 Favorites	<b>Vehicle serviced</b> Oil and filter changed
11/28/2006	20,644	Texas Inspection Station Grapevine, TX	<b>Passed safety inspection</b> Passed emissions inspection
01/01/2007		Texas Motor Vehicle Dept. Southlake, TX Title #05755338360151511	<b>Registration issued or renewed</b> Passed safety inspection
06/26/2007		Van Chevrolet Carrollton, TX 972-389-6700	<b>Vehicle serviced</b>
12/14/2007	33,828	Texas Inspection Station Southlake, TX	<b>Passed emissions inspection</b>
01/01/2008		Texas Motor Vehicle Dept. Southlake, TX Title #05755338360151511	<b>Registration issued or renewed</b> Passed safety inspection
12/30/2008	40,643	Texas Inspection Station Southlake, TX	<b>Passed emissions inspection</b>
01/01/2009		Texas Motor Vehicle Dept. Southlake, TX Title #05755338360151511	<b>Registration issued or renewed</b> Passed safety inspection
12/18/2009	49,073	Texas Inspection Station Southlake, TX	<b>Passed emissions inspection</b>
01/01/2010		Texas	<b>Registration issued or renewed</b>

01/01/2010		Texas Motor Vehicle Dept. Southlake, TX Title #05755338360151511	<b>Registration issued or renewed</b> Passed safety inspection
01/01/2011		Texas Motor Vehicle Dept. Southlake, TX Title #05755338360151511	<b>Registration issued or renewed</b> Passed safety inspection Vehicle color noted as Black
01/10/2011	57,946	Texas Inspection Station Southlake, TX	<b>Passed emissions inspection</b>
08/05/2011	62,159	Jim Olson Motors, Inc. Sturgeon Bay, WI 920-743-4461  <b>4.7 / 5.0</b> 145 Verified Reviews <b>1,25</b> Customer <b>0</b> Favorites	<b>Vehicle serviced</b> Cooling system checked Water pump replaced
01/01/2012		Texas Motor Vehicle Dept. Southlake, TX Title #05755338360151511	<b>Registration issued or renewed</b> Passed safety inspection Vehicle color noted as Black
05/17/2012	65,576	Texas Inspection Station Southlake, TX	<b>Passed emissions inspection</b>
01/01/2013		Texas Motor Vehicle Dept. Southlake, TX Title #05755338360151511	<b>Registration issued or renewed</b> Passed safety inspection Vehicle color noted as Black
08/04/2013		Mustang Elite Lube Center Grapevine, TX 817-442-1663  <b>4.7 / 5.0</b> 117 Verified Reviews	<b>Vehicle serviced</b> Emissions inspection performed
08/04/2013	70,909	Texas Inspection Station Southlake, TX	<b>Passed emissions inspection</b>
11/19/2013	73,673	Classic Chevrolet Grapevine, TX 817-421-1200  <b>4.6 / 5.0</b>	<b>Vehicle serviced</b> Oil and filter changed Tires rotated

 4.6 / 5.0  
886 Verified Reviews  
**14,94** Customer  
**5** Favorites

01/01/2014	Texas Motor Vehicle Dept. Southlake, TX Title #05755338360151511	<b>Registration issued or renewed</b> Passed safety inspection Vehicle color noted as Black
07/23/2014 77,947	Classic Chevrolet Grapevine, TX 817-421-1200  <b>4.6 / 5.0</b> 886 Verified Reviews <b>14,94</b> Customer <b>5</b> Favorites	<b>Vehicle serviced</b>
09/13/2014 81,628	Mustang Elite Lube Center Grapevine, TX 817-442-1663  <b>4.9 / 5.0</b> 163 Verified Reviews  <b>9</b> Customer Favorites	<b>Vehicle serviced</b> Maintenance inspection completed Oil and filter changed Emission system checked
09/13/2014	Texas Inspection Station Southlake, TX	<b>Passed emissions inspection</b>
01/01/2015	Texas Motor Vehicle Dept. Southlake, TX Title #05755338360151511	<b>Registration issued or renewed</b> Passed safety inspection Vehicle color noted as Black
05/11/2015 83,345	Classic Chevrolet Grapevine, TX 817-421-1200  <b>4.6 / 5.0</b> 886 Verified Reviews <b>14,94</b> Customer <b>5</b> Favorites	<b>Vehicle serviced</b> A/C system serviced Tire(s) balanced Tire(s) mounted
05/14/2015	Damage Report	<b>Accident reported</b> Vehicle involved in sideswipe collision with another motor vehicle Damage to left side Damage to rear Airbags did not deploy



**Damage Location**  
FRONT

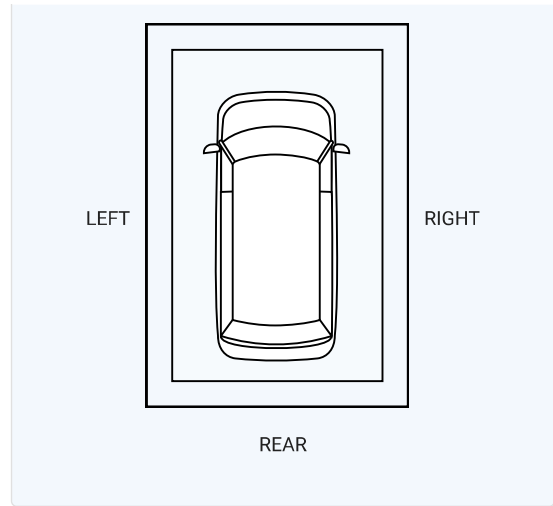

05/22/2015 84,456 Harbor Chevrolet Buick  
GMC  
Michigan City, IN  
219-879-6789

★ 4.0 / 5.0  
16 Verified Reviews

**Vehicle serviced**  
Maintenance inspection completed  
Exterior trim checked

06/02/2015 85,616 Classic Chevrolet  
Grapevine, TX  
817-421-1200

★ 4.6 / 5.0  
886 Verified Reviews  
14,94 Customer  
5 Favorites

**Vehicle serviced**

07/21/2015 85,751 Classic Chevrolet  
Grapevine, TX  
817-421-1200

★ 4.6 / 5.0  
886 Verified Reviews  
14,94 Customer  
5 Favorites

**Vehicle serviced**

08/10/2015 85,827 Classic Chevrolet  
Grapevine, TX  
817-421-1200

★ 4.6 / 5.0  
886 Verified Reviews  
14,94 Customer  
5 Favorites

**Vehicle serviced**

09/14/2015 88,338 Classic Chevrolet  
Grapevine, TX  
817-421-1200

★ 4.6 / 5.0  
886 Verified Reviews  
14,94 Customer  
5 Favorites

**Vehicle serviced**



12/09/2015	88,796	Mustang Elite Lube Center Grapevine, TX 817-442-1663 ★ 4.9 / 5.0 163 Verified Reviews ❤️ 9 Customer Favorites	<b>Vehicle serviced</b> Safety inspection performed Emissions inspection performed
12/09/2015		Texas Inspection Station Southlake, TX	<b>Passed emissions inspection</b>
01/01/2016		Texas Motor Vehicle Dept. Southlake, TX Title #05755338360151511	<b>Registration issued or renewed</b> Passed safety inspection Vehicle color noted as Black
01/18/2016	91,040	Classic Chevrolet Grapevine, TX 817-421-1200 ★ 4.6 / 5.0 886 Verified Reviews 14,94 Customer 5 Favorites	<b>Vehicle serviced</b> Oil and filter changed Tires rotated
08/03/2016	94,570	Classic Chevrolet Grapevine, TX 817-421-1200 ★ 4.6 / 5.0 886 Verified Reviews 14,94 Customer 5 Favorites	<b>Vehicle serviced</b>
11/28/2016	94,897	Mustang Elite Lube Center Grapevine, TX 817-442-1663 ★ 4.9 / 5.0 163 Verified Reviews ❤️ 9 Customer Favorites	<b>Vehicle serviced</b> Safety inspection performed Emissions inspection performed
11/28/2016		Texas Inspection Station Southlake, TX	<b>Passed emissions inspection</b>
01/01/2017		Texas Motor Vehicle Dept. Southlake, TX Title #05755338360151511	<b>Registration issued or renewed</b> Passed safety inspection Vehicle color noted as Black
02/24/2017	95,447	Classic Chevrolet	<b>Vehicle serviced</b>

03/24/2017	95,447	Classic Chevrolet Grapevine, TX 817-421-1200 ★ 4.6 / 5.0 886 Verified Reviews 14,94 Customer 5 Favorites	<b>Vehicle serviced</b>
04/20/2017	97,909	Classic Chevrolet Grapevine, TX 817-421-1200 ★ 4.6 / 5.0 886 Verified Reviews 14,94 Customer 5 Favorites	<b>Vehicle serviced</b> Oil and filter changed Tires rotated
07/17/2017	98,968	Classic Chevrolet Grapevine, TX 817-421-1200 ★ 4.6 / 5.0 886 Verified Reviews 14,94 Customer 5 Favorites	<b>Vehicle serviced</b> Oil and filter changed Tires rotated
04/13/2018	103,028	Mustang Elite Lube Center Grapevine, TX 817-442-1663 ★ 4.9 / 5.0 163 Verified Reviews ♥ 9 Customer Favorites	<b>Vehicle serviced</b> Safety inspection performed Emissions inspection performed
04/13/2018		Texas Inspection Station Southlake, TX	<b>Passed emissions inspection</b>
05/01/2018		Texas Motor Vehicle Dept. Southlake, TX Title #05755338360151511	<b>Registration issued or renewed</b> Passed safety inspection Vehicle color noted as Black
06/25/2018	103,407	Classic Chevrolet Grapevine, TX 817-421-1200 ★ 4.6 / 5.0 886 Verified Reviews 14,94 Customer 5 Favorites	<b>Vehicle serviced</b>
08/01/2018	106,033	Classic Chevrolet Grapevine, TX 817-421-1200 ★ 4.6 / 5.0	<b>Vehicle serviced</b>

886 Verified Reviews  
**14,94** Customer  
5 Favorites

08/02/2018 106,043 Driver's Edge Auto  
Repair  
Southlake, TX  
817-993-6524

★ **4.5 / 5.0**  
27 Verified Reviews  
♥ **66** Customer Favorites

**Vehicle serviced**  
Brake fluid flushed/changed  
Brake master cylinder  
replaced/repaird

09/07/2018 108,757 Classic Chevrolet  
Grapevine, TX  
817-421-1200

★ **4.6 / 5.0**  
886 Verified Reviews  
**14,94** Customer  
5 Favorites

**Vehicle serviced**

12/07/2018 109,179 Pep Boys  
Bedford, TX  
817-283-2588

★ **4.3 / 5.0**  
51 Verified Reviews  
♥ **92** Customer Favorites

**Vehicle serviced**  
Maintenance inspection completed  
Battery serviced  
Battery/charging system checked  
Battery replaced

12/17/2018 109,238 Classic Chevrolet  
Grapevine, TX  
817-421-1200

★ **4.6 / 5.0**  
886 Verified Reviews  
**14,94** Customer  
5 Favorites

**Vehicle serviced**

03/15/2019 110,261 Mustang Elite Lube  
Center  
Grapevine, TX  
817-442-1663

★ **4.9 / 5.0**  
163 Verified Reviews  
♥ **9** Customer Favorites

**Vehicle serviced**  
Emissions inspection performed

03/15/2019 Texas  
Inspection Station  
Southlake, TX





**Passed emissions inspection**



04/10/2019 110,472 Classic Chevrolet  
Grapevine, TX  
817-421-1200

★ **4.6 / 5.0**  
886 Verified Reviews

**Vehicle serviced**  
Oil and filter changed  
Tires rotated

14,94 Customer  
5 Favorites

05/01/2019		Texas Motor Vehicle Dept. Southlake, TX Title #05755338360151511	<b>Registration issued or renewed</b> Passed safety inspection Vehicle color noted as Black
05/31/2019	115,151	Classic Chevrolet Grapevine, TX 817-421-1200  <b>4.6 / 5.0</b> 886 Verified Reviews 14,94 Customer 5 Favorites	<b>Vehicle serviced</b> Oil and filter changed Tires rotated
08/13/2019	115,340	Classic Chevrolet Grapevine, TX 817-421-1200  <b>4.6 / 5.0</b> 886 Verified Reviews 14,94 Customer 5 Favorites	<b>Vehicle serviced</b>
09/24/2019	117,747	Classic Chevrolet	<b>Vehicle serviced</b>
	<b>Owner 2</b> Purchased: 2019		<b>Low mileage!</b> This owner drove less than the industry average of 15,000 miles per year.
			Personal Vehicle 1,695 mi/yr
Date	Mileage	Source	Comments
10/03/2019	118,497	California Inspection Station	<b>Passed emissions inspection</b>

10/14/2019	California Motor Vehicle Dept. Chula Vista, CA	<b>Title issued or updated</b> New owner reported
02/13/2020 122,789	Eastlake Shell Chula Vista, CA 619-656-1107 ★ 4.8 / 5.0 73 Verified Reviews ❤️ 78 Customer Favorites	 <b>Vehicle serviced</b> Maintenance inspection completed Vehicle washed/detailed Engine checked Oil and filter changed
03/18/2021	Service Facility	 <b>Inspection performed</b>



## Glossary

<b>Accident Indicator</b> CARFAX receives information about accidents in all 50 states, the District of Columbia and Canada. Not every accident is reported to CARFAX. As details about the accident become available, those additional details are added to the CARFAX Vehicle History Report. CARFAX recommends that you have this vehicle inspected by a qualified mechanic.	02/12/2022 126,100 Eastlake Shell Chula Vista, CA 619-656-1107 ★ 4.8 / 5.0 73 Verified Reviews ❤️ 78 Customer Favorites	 <b>Vehicle serviced</b> Maintenance inspection completed Oil and filter changed Vehicle washed/detailed Fire condition and pressure checked Brakes checked
<b>First Owner</b> When the first owner(s) obtains a title from a Department of Motor Vehicles as proof of ownership.	02/15/2022 126,193 California Inspection Station	<b>Passed emissions inspection</b>
<b>New Owner Reported</b> When a vehicle is sold to a new owner, the Title must be transferred to the new owner(s) at a Department of Motor Vehicles.	<b>Owner 3</b> Purchased: 2024	Department of Personal Vehicle
<b>Ownership History</b> CARFAX defines an owner as an individual or business that possesses and uses a vehicle. Not all title transactions represent changes in ownership. To provide estimated number of owners, CARFAX proprietary technology analyzes every vehicle history. Estimated number of owners available for vehicles manufactured after 1991 and titled solely in the US including Puerto Rico. Dealers sometimes opt to take ownership of a vehicle and are required to in the following states: Maine, Massachusetts, New Jersey, Ohio, Oklahoma, Pennsylvania and South Dakota. Please consider this as you review a vehicle's estimated ownership history.	<b>Date</b> 10/14/2022 California Motor Vehicle Dept. Waco, TX	<b>Comments</b> New owner reported
<b>Title Issued</b> A state issues a title to provide a vehicle owner with proof of ownership. Each title has a unique number. Each title or registration record on a CARFAX report does not necessarily indicate a change in ownership. In Canada, a registration and bill of sale are used as proof of ownership.	Have Questions? Please visit our Help Center at <a href="http://www.carfax.com">www.carfax.com</a>	

Follow Us:



[facebook.com/CARFAX](https://facebook.com/CARFAX)



@CARFAXinc



About CARFAX

CARFAX DEPENDS ON ITS SOURCES FOR THE ACCURACY AND RELIABILITY OF ITS INFORMATION. THEREFORE, NO RESPONSIBILITY IS ASSUMED BY CARFAX OR ITS AGENTS FOR ERRORS OR OMISSIONS IN THIS REPORT. CARFAX FURTHER EXPRESSLY DISCLAIMS ALL WARRANTIES, EXPRESS OR IMPLIED, INCLUDING ANY IMPLIED WARRANTIES OF MERCHANTABILITY OR FITNESS FOR A PARTICULAR PURPOSE.

© 2022 CARFAX, Inc., part of S&P Global. All rights reserved.

