



# Vehicle History Report™

US \$39.99

## 2009 PORSCHE CAYENNE GTS

VIN: WP1AD29P29LA61400  
4 DOOR WAGON/SPORT  
UTILITY  
4.8L V8 F DOHC 32V  
GASOLINE  
ALL WHEEL DRIVE



Branded Titles: Rebuilt, Salvage



18 Service history records



At least 1 open recall



6 Previous owners



Personal vehicle



100,439 Last reported odometer reading

This CARFAX Vehicle History Report is based only on information supplied to CARFAX and available as of 11/4/22 at 9:52:07 AM (CDT). Other information about this vehicle, including problems, may not have been reported to CARFAX. Use this report as one important tool, along with a vehicle inspection and test drive, to make a better decision about your next used car.



## Ownership History

The number of owners is estimated

Owners 1-4

Owner 5

Owner 6

Year purchased

2009

2022

2022

Type of owner

Personal

Personal

Personal

Estimated length of ownership

12 yrs. 9 mo.

7 months

30 days

Owned in the following states/provinces

See Details

California

North Carolina

Estimated miles driven per year

See Details

---

---

Last reported odometer reading

98,752

---

100,439



## Title History

CARFAX guarantees the information in this section

Owners 1-4

Owner 5

Owner 6

### Damage Brands

Salvage | Junk | Rebuilt | Fire | Flood | Hail | Lemon

**Alert!**  
Problem Found

**Alert!**  
Problem Found

No Additional Problems

### Odometer Brands

Not Actual Mileage | Exceeds Mechanical Limits

No Problem

No Problem

No Problem



**ALERT!** - Severe problems were reported by a state Department of Motor Vehicles (DMV). This vehicle does not qualify for the CARFAX Buyback Guarantee.

<b>CARFAX</b> Additional History Not all accidents / issues are reported to CARFAX	Owners 1-4	Owner 5	Owner 6
<b>Total Loss</b> Total Loss Reported: 02/25/2019.	Total Loss Reported	No New Issues Reported	No New Issues Reported
<b>Structural Damage</b> CARFAX recommends that you have this vehicle inspected by a collision repair specialist.	<input checked="" type="checkbox"/> No Issues Reported	<input checked="" type="checkbox"/> No Issues Reported	<input checked="" type="checkbox"/> No Issues Reported
<b>Airbag Deployment</b> No airbag deployment reported to CARFAX.	<input checked="" type="checkbox"/> No Issues Reported	<input checked="" type="checkbox"/> No Issues Reported	<input checked="" type="checkbox"/> No Issues Reported
<b>Odometer Check</b> No indication of an odometer rollback.	<input checked="" type="checkbox"/> No Issues Indicated	<input checked="" type="checkbox"/> No Issues Indicated	<input checked="" type="checkbox"/> No Issues Indicated
<b>Accident / Damage</b> DMV title problems reported. Damage reported: 03/15/2018 and 02/27/2019. Accidents reported: 02/25/2019 and 06/24/2019. Vehicle sold at a salvage auction: 06/24/2019.	Severe Damage	Severe Damage	No New Issues Reported
<b>Manufacturer Recall</b> At least 1 manufacturer recall requires repair. Most recalls can be repaired free of charge.	<input checked="" type="checkbox"/> No Recalls Reported	Recall Reported	No New Recalls Reported



### Detailed History



**Owner 1**  
Purchased:  
2009

Personal Vehicle

Date	Mileage	Source	Comments
------	---------	--------	----------





















07/28/2008 6	Porsche of Naples Naples, FL 239-280-5100  <b>4.8 / 5.0</b> 93 Verified Reviews  <b>32</b> Customer Favorites	 <b>Vehicle serviced</b> Pre-delivery inspection completed
01/21/2009 30	Porsche of Naples Naples, FL 239-280-5100  <b>4.8 / 5.0</b> 93 Verified Reviews  <b>32</b> Customer Favorites	 <b>Vehicle serviced</b>
03/30/2009 144	Porsche of Naples Naples, FL 239-280-5100	<b>Vehicle sold</b>

★ 4.8 / 5.0  
93 Verified Reviews  
♥ 32 Customer Favorites

04/30/2009 Pennsylvania **Vehicle purchase reported**

 **Owner 2**  
Purchased:  
2010 Personal Vehicle  
11,057 mi/yr

Date	Mileage	Source	Comments
------	---------	--------	----------

vehicle  
Loan or lien reported





07/31/2009	1,527	Wyoming Valley Motors Plymouth, PA 570-288-7411 ★ 4.7 / 5.0 191 Verified Reviews	<b>Vehicle serviced</b> Oil and filter changed
------------	-------	--	---

10/15/2009	4,639	Wyoming Valley Motors Plymouth, PA 570-288-7411 ★ 4.7 / 5.0 191 Verified Reviews	<b>Vehicle serviced</b> Tire(s) balanced
------------	-------	--	---

10/15/2009		Inspection Station	<b>Passed emissions inspection</b>
------------	--	--------------------	------------------------------------

12/18/2009	4,897	Rayco Eurospec Motorcars Kingston, PA 570-288-6459 ★ 4.7 / 5.0 29 Verified Reviews ♥ 66 Customer Favorites	<b>Vehicle serviced</b> Interior cleaned
------------	-------	--	---







06/09/2010		New Jersey Motor Vehicle Dept. Mendham, NJ	<b>Registration issued or renewed</b> Vehicle color noted as Black
------------	--	--	---

06/09/2010	7,755	New Jersey Motor Vehicle Dept. Mendham, NJ Title #MR20101600236	<b>Title issued or updated</b> New owner reported Loan or lien reported Vehicle color noted as Black
09/23/2010	12,459	Paul Miller Porsche Parsippany, NJ 973-575-7756 ★ 4.6 / 5.0 179 Verified Reviews ♥ 2,63 Customer 7 Favorites	 <b>Vehicle serviced</b> Intake manifold gasket(s) replaced Coolant temperature sensor replaced Engine/powertrain computer/module checked Oil and filter changed
01/31/2011	16,755	Paul Miller Porsche Parsippany, NJ 973-575-7756 ★ 4.6 / 5.0 179 Verified Reviews ♥ 2,63 Customer 7 Favorites	 <b>Vehicle serviced</b> Cooling system checked Computer reprogrammed
09/23/2011	24,460	Paul Miller Porsche Parsippany, NJ 973-575-7756 ★ 4.6 / 5.0 179 Verified Reviews ♥ 2,63 Customer 7 Favorites	 <b>Vehicle serviced</b> Recommended maintenance performed
11/07/2012	37,179	Paul Miller Porsche Parsippany, NJ 973-575-7756 ★ 4.6 / 5.0 179 Verified Reviews ♥ 2,63 Customer 7 Favorites	 <b>Vehicle serviced</b> Recommended maintenance performed Parking brake control replaced Wiper(s) replaced
05/30/2013		New Jersey Motor Vehicle Dept. Jersey City, NJ	<b>Registration issued or renewed</b> Vehicle color noted as Black
12/30/2013		Audi of Mendham/Bernardsville Bernardsville, NJ 908-766-0900 ★ 4.5 / 5.0 15 Verified Reviews	<b>Vehicle offered for sale</b>
01/07/2014	47,379	Audi Bridgewater Bridgewater, NJ 908-800-9000 ★ 4.5 / 5.0 15 Verified Reviews	 <b>Vehicle serviced</b> Maintenance inspection completed

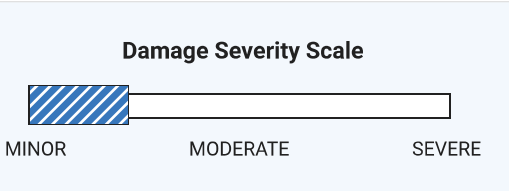
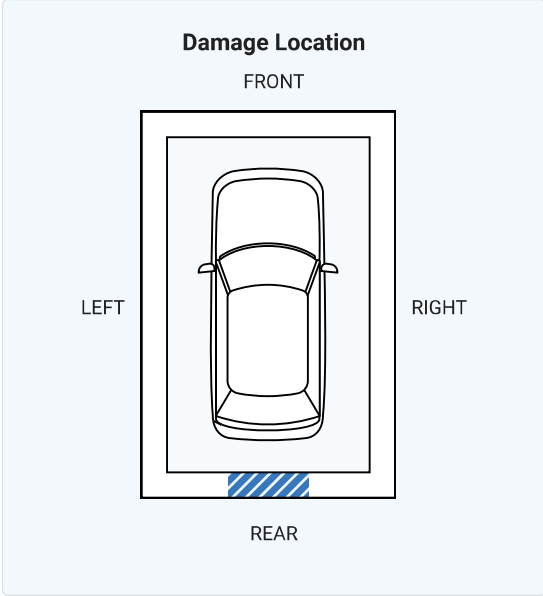

Looks like this dealer serviced the car in order to prepare it for sale. That's a good thing!

01/23/2014		New Jersey Motor Vehicle Dept. Mendham, NJ Title #DA20140230379	<b>Dealer took registration of this vehicle</b> Title issued or updated Dealer took title of this vehicle while it was in inventory Duplicate title issued Vehicle color noted as Black
01/29/2014		New Jersey Motor Vehicle Dept. Mendham, NJ Title #DC20140290120	<b>Title issued or updated</b> Duplicate title issued Vehicle color noted as Black
02/08/2014		Audi Bridgewater Bridgewater, NJ 908-800-9000 ★ 4.5 / 5.0 15 Verified Reviews	<b>Vehicle sold</b>
02/20/2014	47,431	New Jersey Motor Vehicle Dept. Jersey City, NJ Title #DA20140510880	<b>Dealer took registration of this vehicle</b> Title issued or updated Dealer took title of this vehicle while it was in inventory Vehicle color noted as Black
02/04/2015	57,600	Renson Automotive Campbell, CA 408-377-8113 ★ 5.0 / 5.0 36 Verified Reviews ❤️ 20 Customer Favorites	<b>Vehicle serviced</b> Emissions inspection performed
02/04/2015		California Inspection Station	<b>Passed emissions inspection</b>
		<b>Owner 3</b> Purchased: 2015	Personal Vehicle 8,098 mi/yr
Date	Mileage	Source	Comments

02/13/2015	57,920	California Motor Vehicle Dept. San Jose, CA	<b>Title issued or updated</b> New owner reported Registration updated when owner moved the vehicle to a new location
12/06/2016	74,284	California Inspection Station	<b>Passed emissions inspection</b>
12/11/2017	82,758	Dons Wise's Autowerks Campbell, CA 408-871-9108	 <b>Vehicle serviced</b> Oil and filter changed
01/04/2018	83,100	Dons Wise's Autowerks Campbell, CA 408-871-9108	 <b>Vehicle serviced</b> Brakes checked Brake pad sensor(s) replaced Rear brake pads replaced Rear brakes replaced
03/15/2018		Damage Report	 <b>Damage reported: minor damage</b> Damage to rear <div style="margin-top: 10px;">  <div style="display: flex; justify-content: space-around; align-items: center;"> <div style="text-align: center;"> <p><b>Damage Severity Scale</b></p>  </div> <div style="text-align: center;"> <p><b>Damage Location</b></p>  </div> </div> </div>
05/22/2018	85,621	Dons Wise's Autowerks Campbell, CA 408-871-9108	 <b>Vehicle serviced</b> Driveshaft checked
12/03/2018	89,196	Dons Wise's Autowerks Campbell, CA 408-871-9108	 <b>Vehicle serviced</b> Oil and filter changed Washer fluid reservoir cap replaced Windshield washer checked

12/27/2018 89,270

Renson Automotive  
Campbell, CA  
408-377-8113

★ 5.0 / 5.0

36 Verified Reviews

♥ 20 Customer Favorites

**Vehicle serviced**

Emissions inspection performed

12/27/2018 89,720

California  
Inspection Station

**Passed emissions inspection**

02/25/2019

Damage Report

**TOTAL LOSS VEHICLE**

Accident reported  
Vehicle declared a total loss by an insurance company  
Damage to front



There are many reasons an insurance company will declare a vehicle a total loss. Have this vehicle inspected by a qualified technician before you buy. [Learn More](#)

02/27/2019

Damage Report

**Damage reported: minor to moderate damage**

Damage to left front  
Damage to front

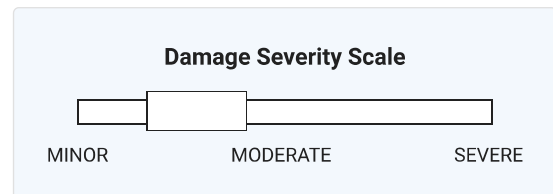

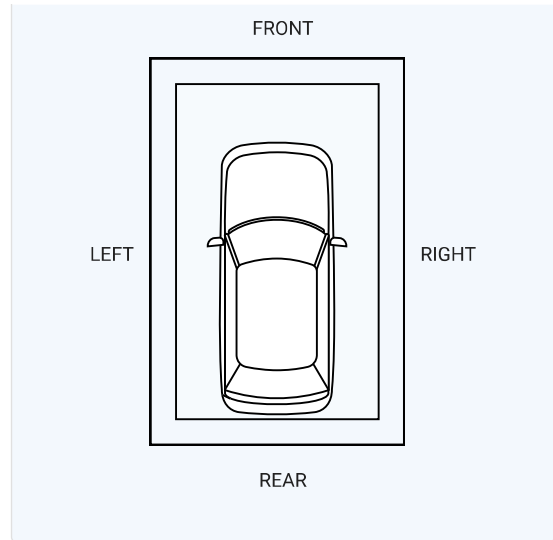

06/06/2019	California Motor Vehicle Dept.	Title or registration issued to insurance company
06/06/2019	California Motor Vehicle Dept. Rancho Cordova, CA	Dealer took title of this vehicle while it was in inventory <b>SALVAGE TITLE/CERTIFICATE ISSUED</b>
06/18/2019	Damage Report	<b>SALVAGE TITLE/CERTIFICATE ISSUED</b>
06/24/2019	Damage Report	Collision damage reported Sold at salvage auction
01/07/2020 91,116	California Inspection Station	Passed emissions inspection

**Owner 4** Personal Vehicle  
 Purchased: 2020

Date	Mileage	Source	Comments
01/22/2020		California Motor Vehicle Dept. Carlsbad. CA	<b>New owner reported</b> <b>REBUILT TITLE ISSUED</b>

**CARFAX** Glossary

**Accident Indicator** 760-721-9494 Emissions or safety inspection performed

CARFAX receives information about accidents in all 50 states, the District of Columbia and Canada.

★ 5.0 / 5.0  
29 Verified Reviews

Not every accident is reported to CARFAX. As details about the accident become available, those additional details are added to the CARFAX Vehicle History Report. CARFAX recommends that you have this vehicle inspected by a qualified mechanic.

12/15/2021 98,752 California **Passed emissions inspection**  
Inspection Station

- According to the National Safety Council, Injury Facts, 2021 edition, 5% of the 276 million registered vehicles in the U.S. were involved in an accident in 2019. Over 77% of these were considered minor

or moderate.  
**Owner 5**  
Purchased:  
2022

Personal Vehicle

This CARFAX Vehicle History Report is based only on information supplied to CARFAX and available as of 11/4/22 at 9:52:07 AM (CDT). Other information about this vehicle, including problems, may not have been reported to CARFAX. Use this report as one important tool, along with a vehicle inspection and test drive, to make a better decision about your next used car.

Date	Mileage	Source	Comments
------	---------	--------	----------

**Damage Indicator**

02/23/2022  
Damage as a result of many different types of events. Examples include contact with objects (other cars, trees, traffic signs, road debris, etc), vandalism or weather-related events. Not every damage event is reported to CARFAX. As details about the damage event become available, those additional details are added to the CARFAX Vehicle History Report. CARFAX recommends that you have this vehicle inspected by a qualified mechanic.

**New owner reported**  
**REBUILT TITLE ISSUED**

08/25/2022  
CARFAX Vehicle History Report is based only on information supplied to CARFAX and available as of 11/4/22 at 9:52:07 AM (CDT). Other information about this vehicle, including problems, may not have been reported to CARFAX. Use this report as one important tool, along with a vehicle inspection and test drive, to make a better decision about your next used car.

**Manufacturer Safety Recall issued**  
Recall #ANB4 REPROFIT SEALING CAP ON FRONT LEFT AND RIGHT MAIN HEADLAMP

**Damage Severity**

Damage events result in one of the following severity levels:

Click here or call 1-800-PORSCHE to locate an authorized Porsche dealer near you.

- Minor: Generally, minor damage is cosmetic (including dents and scratches), may only require reconditioning, and typically does not compromise a vehicle's operation and/or safety.
- Moderate: Moderate damage may affect multiple components of the vehicle and may impair the vehicle's operation and/or safety.

**Learn more about this recall**

**Owner 6**  
Purchased:  
2022

Personal Vehicle

Severe damage usually affects multiple components of the vehicle and is likely to compromise the vehicle's operation and/or safety. CARFAX recommends getting a pre-purchase inspection at a certified collision repair facility.

Date	Mileage	Source	Comments
------	---------	--------	----------

10/05/2022  
Automobile manufacturers issue recalls to inform vehicle owners of a defect or failure to meet minimum federal safety or emissions standards. Manufacturer recalls are repaired at no cost to the customer.

**Title or registration issued**  
**New owner reported**

**New Owner Reported**  
When a vehicle is sold to a new owner, the title must be transferred to the new owner(s) at a Department of Motor Vehicles.

**Ownership History**

CARFAX defines an owner as an individual or business that possesses a vehicle. Not all vehicle transactions represent changes in ownership. To provide estimated number of owners, CARFAX proprietary technology analyzes all the events in a vehicle history. Estimated ownership is available for vehicles manufactured after 1991 and titled solely in the following states: Maine, Massachusetts, New Jersey, Ohio, Oklahoma, Pennsylvania and South Dakota. Please consider this as you review a vehicle's estimated ownership history.

Hold on, it looks like the rebuilt title from California didn't get transferred to North Carolina. The number of owners was not properly updated. Get an inspection before you buy. [Learn More](#)

10/26/2022 100,439 Torque Automotive  
**Rebuilt/Reconstructed Title** Raleigh, NC  
A Rebuilt/Reconstructed vehicle is a vehicle that has been repaired and returned to operation. These vehicles are often severely damaged before they are rebuilt and refurbished parts are typically used during reconstruction. In most states, an inspection of the vehicle is required before the vehicle is allowed to return to the road.

**Vehicle serviced**  
Four tires balanced

4.9/5.0  
28 Verified Reviews  
 4 Customer Favorites

**Salvage Auction Record**

Most vehicles sold at Salvage auctions were declared totaled by insurance companies. Most of these vehicles have sustained significant damage. Rebuilders and Recyclers purchase these vehicles at auction with intentions to rebuild them or dismantle them for parts.

**Salvage Title**

A Salvage Title is issued on a vehicle damaged to the extent that the cost of repairing the vehicle exceeds approximately 75% of its pre-damage value. This damage threshold may vary by state. Some states treat Junk



titles the same as Salvage but the majority use this title to indicate that a vehicle is not road worthy and cannot be titled again in that state. The following eleven states also use Salvage titles to identify stolen vehicles - AZ, FL, GA, IL, MD, MN, NJ, NM, NY, OK and OR.

#### **Title Issued**

A state issues a title to provide a vehicle owner with proof of ownership. Each title has a unique number. Each title or registration record on a CARFAX report does not necessarily indicate a change in ownership. In Canada, a registration and bill of sale are used as proof of ownership.

#### **Title Washing**

Title Washing is the process through which a vehicle's title is altered to conceal information that would normally be included. This can be accomplished by either physically altering printed documents or reapplying for a title without disclosing its prior history. Since the CARFAX database retains information about branded titles from all 50 states and the Canadian provinces, the CARFAX Report may help uncover potential title washing.

#### **Total Loss Vehicle**

An insurance or fleet company declares a vehicle a total loss when a claim exceeds approximately 75% of its pre-damage value or if the vehicle is stolen and not recovered. This damage threshold varies by company. These companies typically take possession and obtain the title. Not all total loss vehicles result in a DMV-reported branded title. This may occur when an insurance company's definition of a total loss is different than the state DMV's definition for a branded title or when the owner of the vehicle is a self-insured company, like a fleet or rental company.

**Follow Us:**  [facebook.com/CARFAX](https://facebook.com/CARFAX)  [@CARFAXinc](https://twitter.com/CARFAXinc)  [About CARFAX](#)

CARFAX DEPENDS ON ITS SOURCES FOR THE ACCURACY AND RELIABILITY OF ITS INFORMATION. THEREFORE, NO RESPONSIBILITY IS ASSUMED BY CARFAX OR ITS AGENTS FOR ERRORS OR OMISSIONS IN THIS REPORT. CARFAX FURTHER EXPRESSLY DISCLAIMS ALL WARRANTIES, EXPRESS OR IMPLIED, INCLUDING ANY IMPLIED WARRANTIES OF MERCHANTABILITY OR FITNESS FOR A PARTICULAR PURPOSE.

© 2022 CARFAX, Inc., part of S&P Global. All rights reserved.  
11/4/22 9:52:07 AM (CDT)