



# Vehicle History Report™

US \$39.99

## 2011 LAND ROVER RANGE ROVER SPORT HSE

VIN: SALSF2D44BA277921  
4 DOOR WAGON/SPORT  
UTILITY  
5.0L V8 F DOHC 32V  
GASOLINE  
REAR WHEEL DRIVE W/ 4X4

### Minor to moderate damage

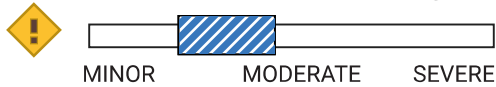

**19** Service history records

**2** Previous owners

Types of owners: Corporate, Personal

**53,697** Last reported odometer reading

This CARFAX Vehicle History Report is based only on information supplied to CARFAX and available as of 11/3/22 at 4:11:24 PM (CDT). Other information about this vehicle, including problems, may not have been reported to CARFAX. Use this report as one important tool, along with a vehicle inspection and test drive, to make a better decision about your next used car.

<b>Ownership History</b> The number of owners is estimated	Owner 1	Owner 2
Year purchased	2011	2013
Type of owner	Corporate	Personal
Estimated length of ownership	2 yrs. 9 mo.	9 years
Owned in the following states/provinces	Florida	See Details
Estimated miles driven per year	6,856/yr	3,735/yr
Last reported odometer reading	18,313	53,697

<b>Title History</b> CARFAX guarantees the information in this section	Owner 1	Owner 2
<b>Damage Brands</b> Salvage   Junk   Rebuilt   Fire   Flood   Hail   Lemon	<b>Guaranteed</b> No Problem	<b>Guaranteed</b> No Problem
<b>Odometer Brands</b> Not Actual Mileage   Exceeds Mechanical Limits	<b>Guaranteed</b> No Problem	<b>Guaranteed</b> No Problem



**GUARANTEED** - None of these major title problems were reported by a state Department of Motor Vehicles (DMV). If you find that any of these title problems were reported by a DMV and not included in this report, CARFAX will buy this vehicle back.

 <b>Additional History</b> Not all accidents / issues are reported to CARFAX	Owner 1	Owner 2
<b>Total Loss</b> No total loss reported to CARFAX.	<input checked="" type="checkbox"/> No Issues Reported	<input checked="" type="checkbox"/> No Issues Reported
<b>Structural Damage</b> CARFAX recommends that you have this vehicle inspected by a collision repair specialist.	<input checked="" type="checkbox"/> No Issues Reported	<input checked="" type="checkbox"/> No Issues Reported
<b>Airbag Deployment</b> No airbag deployment reported to CARFAX.	<input checked="" type="checkbox"/> No Issues Reported	<input checked="" type="checkbox"/> No Issues Reported
<b>Odometer Check</b> No indication of an odometer rollback.	<input checked="" type="checkbox"/> No Issues Indicated	<input checked="" type="checkbox"/> No Issues Indicated
<b>Accident / Damage</b> Damage reported: 07/03/2017.	<input checked="" type="checkbox"/> No Issues Reported	Damage Reported
<b>Manufacturer Recall</b> No open recalls reported to CARFAX. Check with an authorized Land Rover dealer for any open recalls.	<input checked="" type="checkbox"/> No Recalls Reported	<input checked="" type="checkbox"/> No Recalls Reported



## Detailed History



**Owner 1**  
 Purchased:  
 2011



**Low mileage!** This owner drove less than the industry average of 15,000 miles per year.

Corporate  
 Vehicle  
 6,856 mi/yr

Date	Mileage	Source	Comments
------	---------	--------	----------





















12/31/2010	8	Land Rover Palm Beach West Palm Beach, FL 561-209-7000 ★ 4.7 / 5.0 276 Verified Reviews ♥ 3,55 Customer 2 Favorites		<b>Vehicle serviced</b> Pre-delivery inspection completed Nitrogen fill tires
01/10/2011		Land Rover Palm Beach West Palm Beach, FL 561-209-7000 ★ 4.7 / 5.0 276 Verified Reviews ♥ 3,55 Customer 2 Favorites		<b>Vehicle serviced</b> Vehicle washed/detailed
01/12/2011	17	Florida Motor Vehicle Dept.		<b>Vehicle purchase reported</b> Titled or registered as corporate vehicle
01/27/2011		Florida Motor Vehicle Dept. Fort Worth, TX Title #0105721808		<b>Title issued or updated</b> First owner reported Loan or lien reported Vehicle color noted as White
12/12/2011	6,116	Land Rover Palm Beach West Palm Beach, FL 561-209-7000 ★ 4.7 / 5.0 276 Verified Reviews ♥ 3,55 Customer 2 Favorites		<b>Vehicle serviced</b> Maintenance inspection completed 15,000 mile service performed Cup holder replaced Engine/powertrain computer/module checked
01/05/2012	6,641	Land Rover Palm Beach West Palm Beach, FL 561-209-7000 ★ 4.7 / 5.0 276 Verified Reviews ♥ 3,55 Customer 2 Favorites		<b>Vehicle serviced</b> One tire mounted One tire balanced
01/24/2012		Florida Motor Vehicle Dept. Boca Raton, FL Title #0105721808		<b>Registration issued or renewed</b> Loan or lien reported Vehicle color noted as White
08/16/2012	11,755	Land Rover Palm Beach West Palm Beach, FL 561-209-7000 ★ 4.7 / 5.0 276 Verified Reviews		<b>Vehicle serviced</b> Maintenance inspection completed Engine/powertrain computer/module checked Water pump replaced Cooling system checked



		<p>▼ <b>3,55</b> Customer 2 Favorites</p>	<p>Cooling system checked Vehicle washed/detailed</p>
09/05/2012	11,879	<p>Land Rover Palm Beach West Palm Beach, FL 561-209-7000</p> <p>★ <b>4.7 / 5.0</b> 276 Verified Reviews</p> <p>▼ <b>3,55</b> Customer 2 Favorites</p>	<p><b>Vehicle serviced</b></p>
09/26/2012		<p>Land Rover Palm Beach West Palm Beach, FL 561-209-7000</p> <p>★ <b>4.7 / 5.0</b> 276 Verified Reviews</p> <p>▼ <b>3,55</b> Customer 2 Favorites</p>	<p><b>Vehicle serviced</b></p>
01/07/2013		<p>Florida Motor Vehicle Dept. Boca Raton, FL Title #0105721808</p>	<p><b>Registration issued or renewed</b> Loan or lien reported Vehicle color noted as White</p>
07/11/2013	17,475	<p>Land Rover Palm Beach West Palm Beach, FL 561-209-7000</p> <p>★ <b>4.7 / 5.0</b> 276 Verified Reviews</p> <p>▼ <b>3,55</b> Customer 2 Favorites</p>	<p><b>Vehicle serviced</b> Maintenance inspection completed 30,000 mile service performed</p>
09/12/2013	18,313	<p>Land Rover Palm Beach West Palm Beach, FL 561-209-7000</p> <p>★ <b>4.7 / 5.0</b> 276 Verified Reviews</p>	<p><b>Vehicle serviced</b> Battery/charging system checked Battery replaced Computer(s) checked</p>
 <p><b>Owner 2</b> Purchased: 2013</p>		<p><b>Low mileage!</b> This owner drove less than the industry average of 15,000 miles per year.</p>	<p>Personal Vehicle 3,735 mi/yr</p>
Date	Mileage	Source	Comments

10/28/2013	Florida Motor Vehicle Dept.	<b>Vehicle purchase reported</b>
12/10/2013	Florida Motor Vehicle Dept. Boca Raton, FL Title #0105721808	<b>Title issued or updated</b> New owner reported Titled or registered as personal vehicle Loan or lien reported Vehicle color noted as White
01/24/2014	Florida Motor Vehicle Dept. Boca Raton, FL Title #0105721808	<b>Registration issued or renewed</b> Titled or registered as personal vehicle Loan or lien reported Vehicle color noted as White
12/29/2014	Florida Motor Vehicle Dept. Boca Raton, FL Title #0105721808	<b>Registration issued or renewed</b> Titled or registered as personal vehicle Loan or lien reported Vehicle color noted as White
01/15/2015 24,813	Land Rover Palm Beach West Palm Beach, FL 561-209-7000 ★ 4.7 / 5.0 276 Verified Reviews ❤️ 3,55 Customer Favorites 2	 <b>Vehicle serviced</b> Maintenance inspection completed Engine/powertrain computer/module reprogrammed Key(s) (re) programmed Cooling system checked Leak detection pump replaced Computer(s) checked Battery replaced
01/26/2016	Florida Motor Vehicle Dept. Boca Raton, FL Title #0105721808	<b>Registration issued or renewed</b> Titled or registered as personal vehicle Loan or lien reported Vehicle color noted as White
01/25/2017	Florida Motor Vehicle Dept. Boca Raton, FL Title #0105721808	<b>Registration issued or renewed</b> Titled or registered as personal vehicle Loan or lien reported Vehicle color noted as White
03/07/2017 32,683	Land Rover Palm Beach West Palm Beach, FL 561-209-7000 ★ 4.7 / 5.0 276 Verified Reviews ❤️ 3,55 Customer Favorites 2	 <b>Vehicle serviced</b> Vehicle washed/detailed Hood latch replaced
03/21/2017 32,750	Land Rover Palm Beach West Palm Beach, FL	 <b>Vehicle serviced</b> Right front window regulator replaced

561-209-7000

★ 4.7 / 5.0

276 Verified Reviews

▼ 3,55 Customer Favorites

Window regulator(s) replaced  
Battery replaced  
Battery/charging system checked

07/03/2017

Damage Report

**Damage reported: minor to moderate damage**

Damage to front  
Damage to rear  
Damage to right side  
Damage to right front



**Damage Severity Scale**

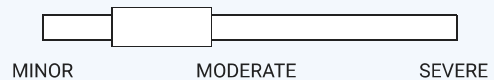

**Damage Location**

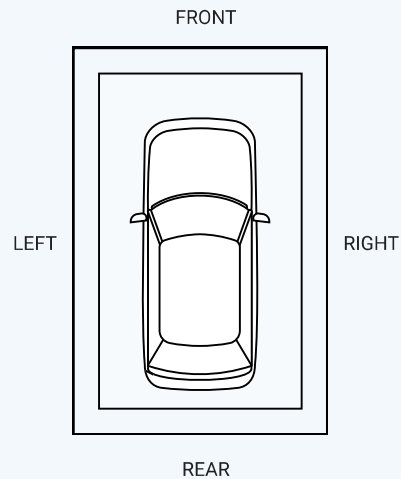

08/15/2017 34,436

Jaguar Land Rover Fort  
Lauderdale  
Pompano Beach, FL  
954-949-0654

★ 4.5 / 5.0

112 Verified Reviews

♥ 92 Customer Favorites

**Vehicle serviced**

Maintenance inspection completed  
Four wheel alignment performed  
Battery/charging system checked  
Brakes checked  
Tire condition and pressure checked

01/19/2018

Florida  
Motor Vehicle Dept.  
Boca Raton, FL  
Title #0105721808

**Registration issued or renewed**

Titled or registered as personal  
vehicle  
Loan or lien reported  
Vehicle color noted as White

11/26/2018

Florida  
Motor Vehicle Dept.

**Registration issued or renewed**

Titled or registered as personal

		Boca Raton, FL Title #0105721808	vehicle Vehicle color noted as White
01/04/2019		Florida Motor Vehicle Dept. Boca Raton, FL Title #0105721808	<b>Title issued or updated</b> Registration issued or renewed Titled or registered as personal vehicle Loan or lien reported Vehicle color noted as White
12/04/2019	43,362	My Mechanic Englewood, FL 941-623-5289 ★ 5.0 / 5.0 47 Verified Reviews ❤️ 12 Customer Favorites	<b>Vehicle serviced</b> Tire(s) replaced Oil and filter changed Two tires mounted Two tires balanced
12/30/2019	44,174	Jaguar Land Rover Fort Myers Fort Myers, FL 239-454-4444 ★ 4.8 / 5.0 445 Verified Reviews 4,26 Customer Favorites	<b>Vehicle serviced</b> Four wheel alignment performed
03/12/2020		Florida Motor Vehicle Dept. Boca Raton, FL Title #0105721808	<b>Registration issued or renewed</b> Titled or registered as personal vehicle Loan or lien reported Vehicle color noted as White
01/11/2021	48,630	High Gear Automotive Englewood, FL 941-475-0198 ★ 4.9 / 5.0 77 Verified Reviews ❤️ 7 Customer Favorites	<b>Vehicle serviced</b> Drivability/performance checked Tire condition and pressure checked Air filter replaced Air suspension compressor replaced/repared Water pump replaced Four wheel alignment performed
02/12/2021		Florida Motor Vehicle Dept. Boca Raton, FL Title #0105721808	<b>Registration issued or renewed</b> Titled or registered as personal vehicle Loan or lien reported Vehicle color noted as White
02/07/2022		Florida Motor Vehicle Dept. Boca Raton, FL Title #0105721808	<b>Registration issued or renewed</b> Titled or registered as personal vehicle Loan or lien reported Vehicle color noted as White
05/21/2022		Walmart Auto Care	<b>Vehicle serviced</b>

Center  
Englewood, FL  
941-474-8953

★ 4.6 / 5.0  
66 Verified Reviews

Oil and filter changed

06/04/2022 53,196

Land Rover Palm Beach  
West Palm Beach, FL  
561-209-7000

★ 4.7 / 5.0  
276 Verified Reviews

**Vehicle serviced**

Have Questions? Please Visit our Help Center at [www.carfax.com](http://www.carfax.com)



## Glossary

### Damage Indicator

Damage can be a result of many different types of events. Examples include contact with objects (other cars, trees, traffic signs, road debris, etc), vandalism, or weather-related events. Not every damage event is reported to CARFAX. As details about the damage event become available, those additional details are added to the CARFAX Vehicle History Report. CARFAX recommends that you have this vehicle inspected by a qualified mechanic.

- This CARFAX Vehicle History Report is based only on information supplied to CARFAX and available as of 11/3/22 at 4:11:24 PM (CDT). Other information about this vehicle, including problems, may not have been reported to CARFAX. Use this report as one important tool, along with a vehicle inspection and test drive, to make a decision about your next used car.

### Damage Severity

Damage events result in one of the following severity levels:

10/07/2022 53,697

Pennsylvania  
Motor Vehicle Dept.  
Philadelphia, PA  
Title #0319090001 RE

**Title issued or updated**

Dealer took title of this vehicle while it was in inventory

- Minor: Generally, minor damage is cosmetic (including dents or scratches) and may only require reconditioning, and typically does not compromise a vehicle's operation and/or safety.
- Moderate: Moderate damage may affect multiple components of the vehicle and may impair the vehicle's operation and/or safety.

10/20/2022

Ohio  
Motor Vehicle Dept.  
Toledo, OH  
Title #4806377042

**Registration issued or renewed**

Severe: Severe damage usually affects multiple components of the vehicle and is likely to compromise the vehicle's operation and/or safety.

CARFAX recommends getting a pre-purchase inspection at a certified collision repair facility.

### First Owner

When the first owner(s) obtains a title from a Department of Motor Vehicles as proof of ownership.

### New Owner Reported

When a vehicle is sold to a new owner, the Title must be transferred to the new owner(s) at a Department of Motor Vehicles.

### Ownership History

CARFAX defines an owner as an individual or business that possesses and uses a vehicle. Not all title transactions represent changes in ownership. To provide estimated number of owners, CARFAX proprietary technology analyzes all the events in a vehicle history. Estimated ownership is available for vehicles manufactured after 1991 and titled solely in the US including Puerto Rico. Dealers sometimes opt to take ownership of a vehicle and are required to in the following states: Maine, Massachusetts, New Jersey, Ohio, Oklahoma, Pennsylvania and South Dakota. Please consider this as you review a vehicle's estimated ownership history.

### Title Issued

A state issues a title to provide a vehicle owner with proof of ownership. Each title has a unique number. Each title or registration record on a CARFAX report does not necessarily indicate a change in ownership. In Canada, a registration and bill of sale are used as proof of ownership.

Follow Us:  [facebook.com/CARFAX](https://facebook.com/CARFAX)  [@CARFAXinc](https://twitter.com/CARFAXinc)  **About CARFAX**

CARFAX DEPENDS ON ITS SOURCES FOR THE ACCURACY AND RELIABILITY OF ITS INFORMATION. THEREFORE, NO RESPONSIBILITY IS ASSUMED BY CARFAX OR ITS AGENTS FOR ERRORS OR OMISSIONS IN THIS REPORT. CARFAX FURTHER EXPRESSLY DISCLAIMS ALL WARRANTIES, EXPRESS OR IMPLIED, INCLUDING ANY IMPLIED WARRANTIES OF MERCHANTABILITY OR FITNESS FOR A PARTICULAR PURPOSE.

© 2022 CARFAX, Inc., part of S&P Global. All rights reserved.  
11/3/22 4:11:24 PM (CDT)